



# Tote Bag

## Introduction

For this project, you will make a tote bag using sturdy fabric. This design is a simple, square-bottom bag with a full lining. The handles are doubled and stitched for durability.

As an option, you can attach a pocket to the inside lining. Then by adding stitching, you can divide the pocket into 3 compartments for small objects such as a cell phone and/or a pen.

Measurements for a larger and a smaller tote bag are included at the end.

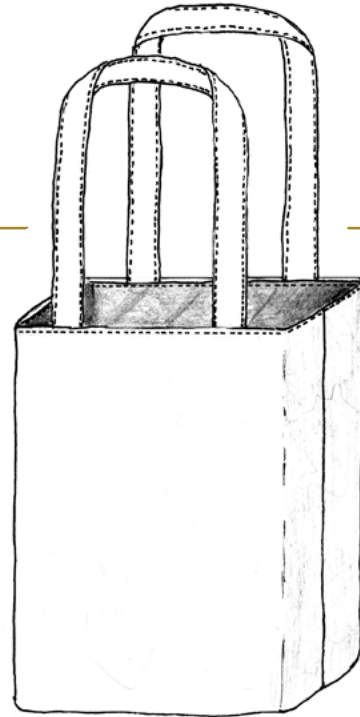

## Tools, Supplies & Materials





You will need the following sewing tools\* and household items to complete a tote bag.

### Tools & Equipment

- Sewing machine
- Steam iron & ironing board
- Rotary cutter\*, cutting mat\* & grid ruler\*
- Straight pins
- 4" Sewing scissors\*
- Marking pencil or chalk marker\*
- Point turner

### Fabric & Notions

- 1/2 yard, 54" fabric for the outer bag  
Use a sturdy fabric such as denim, twill, poplin or a lightweight upholstery fabric. Press a swatch of fabric before using to make sure it will not melt at ironing temperatures.
- 1/2 yard fabric for the lining and pocket  
We recommend a lighter-weight fabric such as cotton or a cotton/polyester blend.
- Thread to match fabrics

-  Right side of tote bag fabric
-  Wrong side of tote bag fabric
-  Right side of lining
-  Wrong side of lining

\* See Sewing Suppliers List at end of document.

## Instructions

### Cutting Out

Use a rotary cutting system or pattern to cut out the main part of your tote bag. Cut both pieces together, remembering to trim off the selvage edges first.

### Main Tote Bag

- Cut 2 rectangles 15" x 14".

**Note:** When using a directional fabric, orient the design up and down along the 14" side.

### Handles

- From the same fabric, cut 2 handle pieces 4" x 19" with the [lengthwise grain](#).

### Lining & Pocket

- From a lighter-weight fabric, cut 2 lining pieces 13 <sup>3</sup>/<sub>4</sub>" x 15".
- Cut 2 pocket pieces 7 <sup>1</sup>/<sub>2</sub>" x 9 <sup>1</sup>/<sub>2</sub>".

**Option:** You can make the pockets any size.

### Prepare the Handles

- Fold the handle pieces in half lengthwise, wrong sides together. Press flat as you fold.
- Open the handle up. Fold one edge inward, just slightly short of the crease. There should be a small gap down the center, between the 2 edges. Iron flat. Repeat with the other edge.



- Fold it in half again, edges together. Press. Pin the edges together.

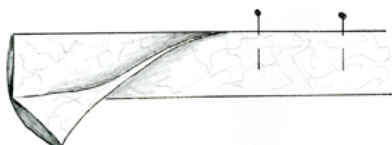

- Topstitch the edges down, sewing right up to the pins before you pull them. Keep some tension on the fabric from behind as you sew, to keep the top fabric from inching forward. Repeat with the second handle.

**Tip:** You might find it helpful to use a [topstitching foot](#) (sometimes called a blind hem foot) instead of your regular presser foot. After attaching it, move your needle position to the left. The guide on this foot will help you keep a straight stitching line even though you have a lot of thickness in the seam.

- Topstitch down the other side of the first handle. Then repeat with the second handle.



### Sewing the Tote Bag

#### Prepare the Bag Pieces

- Place the 2 bag pieces right sides together. Cut a 1 <sup>5</sup>/<sub>8</sub>" square out of the bottom corners of one of the 15" side, being careful *not to over cut* into the bag fabric.

**Note:** If you are using directional fabric, make sure the design is placed right-side up to the top before you cut.

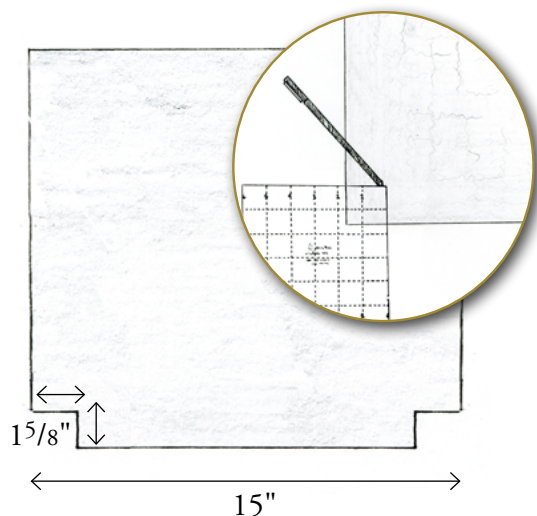

- Pin the 2 bottom (short) edges together. Change the foot back to the regular presser foot. Sew with a  $\frac{5}{8}$ " seam allowance.

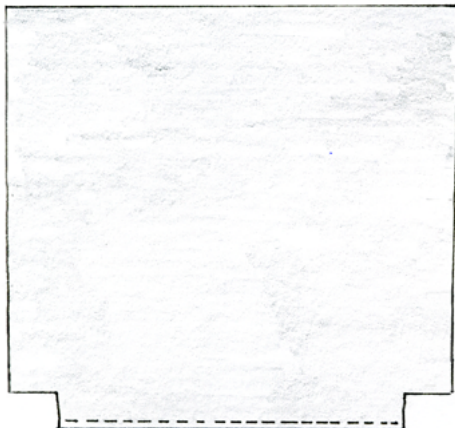

### Prepare the Lining

- Repeat with the lining pieces, cutting both  $1\frac{5}{8}$ " corners at the bottom and then stitching the bottom edges together.

### Prepare the Pocket

- Place the 2 pocket pieces right sides together and pin. You will need to leave a 3" opening along one of the *short* sides. Mark the opening with a marker or chalk wheel.
- Sew the pocket pieces together beginning with the lower edge of the opening, using a  $\frac{3}{8}$ " seam allowance. Backstitch where you begin and end your seam. Pivot the corners.
- Trim the corners diagonally to reduce extra bulk. Turn the pocket right side out. Then poke the corners out.

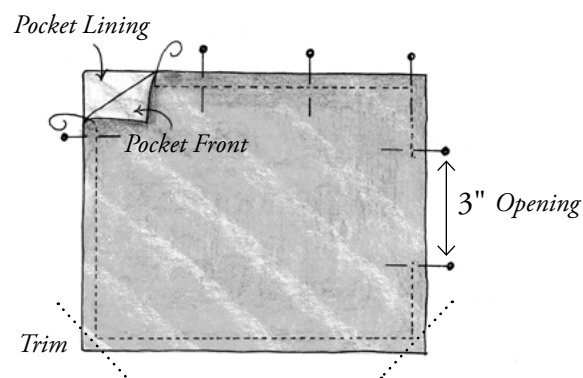

- Roll the seams and press all of the edges flat.
- Topstitch across one long edge. This will be the top of the pocket.

### Attach the Pocket to the Lining

To attach the pocket, you will want to center it on the lining.

- Fold the top lining piece in half wrong sides together. Press a crease in the center.
- Fold the pocket in half short edges together. Press in a crease.
- Place the creased lining right-side up on a flat surface. Place a grid ruler on the lining with the bottom edge of the ruler 3" below the top edge of the fabric.
- Line up the top (stitched) edge of the pocket with the lower edge of the ruler. Center the crease on the pocket over the crease on the lining. Pin the unstitched edges of the pocket in place.

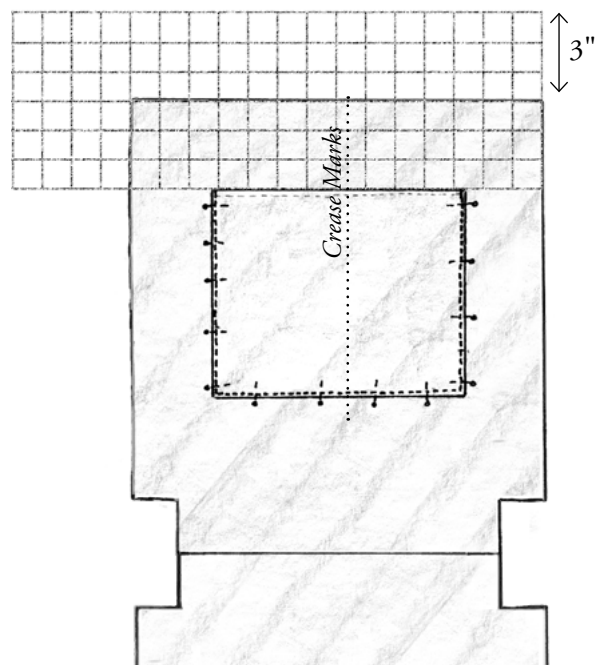

- Edge stitch the sides and bottom of the pocket onto the lining, pivoting the corners. Do not stitch down the fourth, top-stitched side.

**Note:** Always backstitch well at the beginning and end of a pocket seam. Pocket tops receive a lot of stress.

### Pocket Options

At this stage you can divide the pocket into compartments by adding stitching.

- *For a cell phone pocket*

Measure over 3 1/2" from the top edge of the pocket. Mark along the edge of the ruler.

Then measure 4 inches down from the top edge and mark again.

- *For a pen pocket*

Measure 1" over from the top edge and mark.

Then measure 5" down and mark again.

- Stitch on these lines to make the pockets.

**Hint:** Lift up the presser foot up to move the fabric from seam to seam. Backstitch all seams securely. Clip your threads.

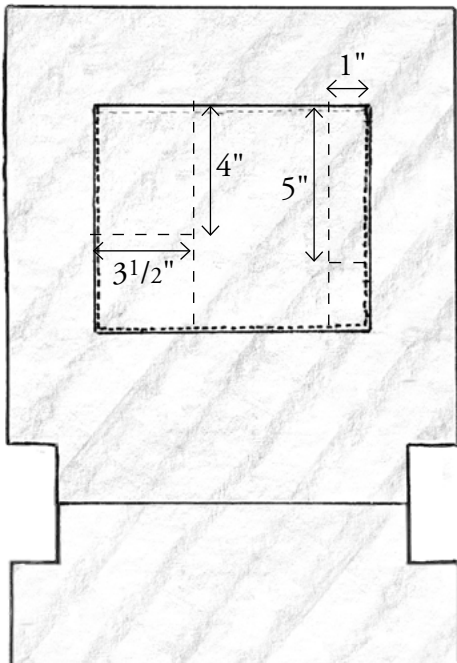

- *For a second pocket inside the bag*

If you would like an additional pocket, cut out another pocket/liner set.

Repeat the sewing instructions, placing the new pocket on the other half of the lining.

You can make pockets any the size, with or without compartments.

### Sew the Side Seams of the Bag & Lining

- Fold the right sides of the outer bag together and pin the 2 sides in place.

- Likewise, place the right sides of the lining together and pin.

You will want to leave about a 5" opening in the middle of one the sides of the lining. Use double pins or a marker to mark the opening.

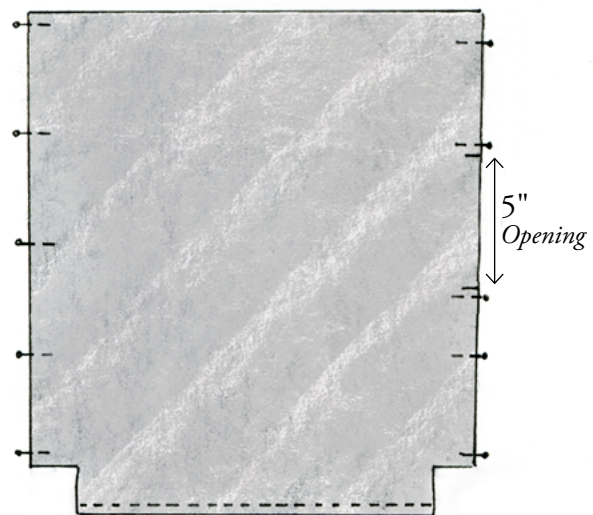

- Sew the side seams of the bag using a 5/8" seam allowance.

- Then sew the side seams of the lining with a 5/8" seam allowance, leaving the opening unstitched. Backstitch well.

- Press the seams open on both pieces.



### Sew the Corners

- To form the base of bag, fold the cut out corners together, matching the seams. Pin.
- Repeat for the lining.
- Stitch the corners on both with a  $\frac{5}{8}$ " seam allowance, beginning with the fold.

**Note:** Make sure your seams stay open *flat*. You do not want to stitch them folded over.

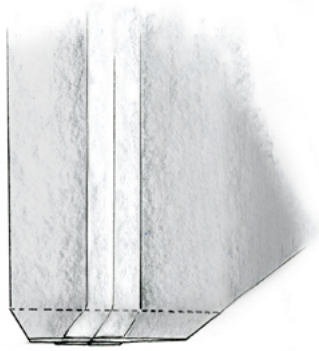

### Add the Handles

- Turn the outer bag right-side out. Measure 3" from one side seam and pin to mark. Repeat with other side seam.

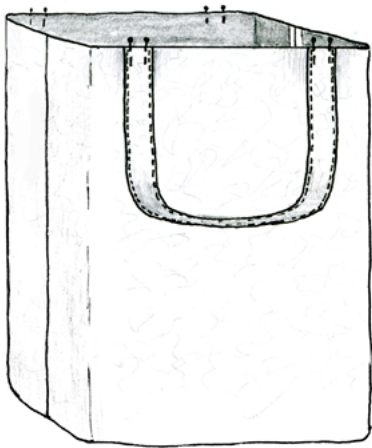

- Repeat with the back of the bag.
- Pin a handle onto the front side of the bag at the marks. *Make sure the handles are not twisted!* Then pin the back handle in place.

- Stitch the handles with a  $\frac{1}{2}$ " seam allowance. Backstitch *well* to strengthen.

### Attach the Lining

- Slide the bag into the lining, right sides together. Fit the lining inside the bag, matching the side seams.
- Pin around the top, starting with the side seams.

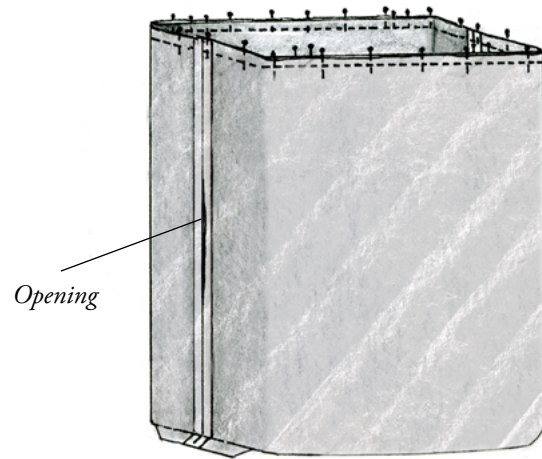

- Carefully stitch around the top edge using a  $\frac{5}{8}$ " seam allowance, easing in any fullness between the pins. Make sure the seam allowance stays open at the seams and the top edges are even.

### Finish the Bag

- Turn the bag to the outside through the opening in the lining.

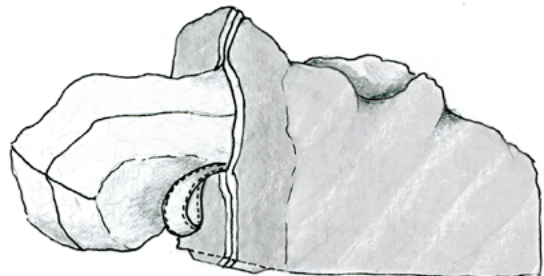

- Tuck the lining inside the bag.

- Before pressing the seam, roll the lining slightly to the inside – you don't want it to show at all on the outside. Press the upper edge, all the way around.

### Top Stitch the Upper Edge

Change the presser foot back to the topstitch foot. This will help you sew straight on the thick layers.

If necessary, change the thread on your machine to match the fabric. The top thread should match the outer fabric and the bobbin thread should match lining.

- Using a long stitch, carefully edge stitch around the outside upper edge of the bag.

**Tip:** Stitching over the handles might be a bit tricky, depending on the bulkiness of the layers. You may have to lift the presser foot up a little to help it over the thickness.

- As you finish, overlap your stitches about 1/2". Then take a couple of short stitches to secure the end.
- Close the opening in the lining by topstitching it.

Your tote bag is now complete!

### Optional Sizes

- To make a Large Tote Bag or a Child's Tote, follow the project sewing directions on the preceding pages, cutting the fabric pieces as shown.

Review this video: [Project 11: Tote Bag](#)

Watch the next video: [Project 12: Lined Apron](#)

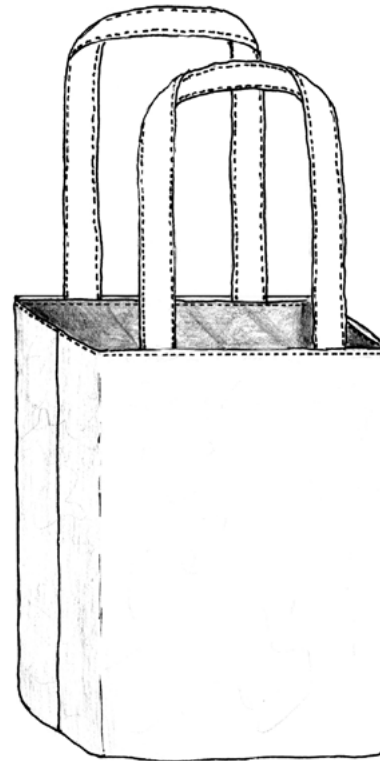

Cutting Measurements for Large & Small Bags

#	Pieces	Large Tote	Small (Child's)
<i>from heavier-weight fabric, cut:</i>			
2	Outer Bag	16" x 18"	10" x 10 1/2"
2	Handles	4" x 21"	4" x 13"
<i>from lighter-weight fabric, cut:</i>			
2	Lining	16" x 17 3/4"	10" x 10 1/4"
2	Pockets	7 1/2" x 9 1/2"	None

## Questions about Sewing?

---

Submit any questions for Crissa in the Q&A section on the course homepage or post it to our blog at [www.sustainlife.org/blog/category/sewing/](http://www.sustainlife.org/blog/category/sewing/)

## Sewing Suppliers

---

### Simply Fabrics

6408 Gholson Road  
Waco, Texas 76705  
254.829.7119  
[info@simplyfabrics.com](mailto:info@simplyfabrics.com)

## Additional Videos

---

### Beginning Sewing

- [Introduction to Sewing](#)
- [Introducing the Projects](#)
- [Notions & Fabrics](#)
- [Sewing Machine](#)
- [Cutting Methods](#)
- [Foundational Practice Sampler](#)

### Project Videos

- [1 Tissue Holder](#)
- [2 Shoe Bag](#)
- [3 Gift Bag](#)
- [4 Double Drawstring Bag](#)
- [5 Bag Caddie](#)
- [6 Bread Cloth](#)
- [7 Basic Pillowcase](#)
- [8 Lined Drawstring Bag](#)
- [9 Pillowcase with Contrasting Band](#)
- [10 Flange Pillow](#)
- [12 Lined Apron](#)